

Sistemas fachada de vidrio

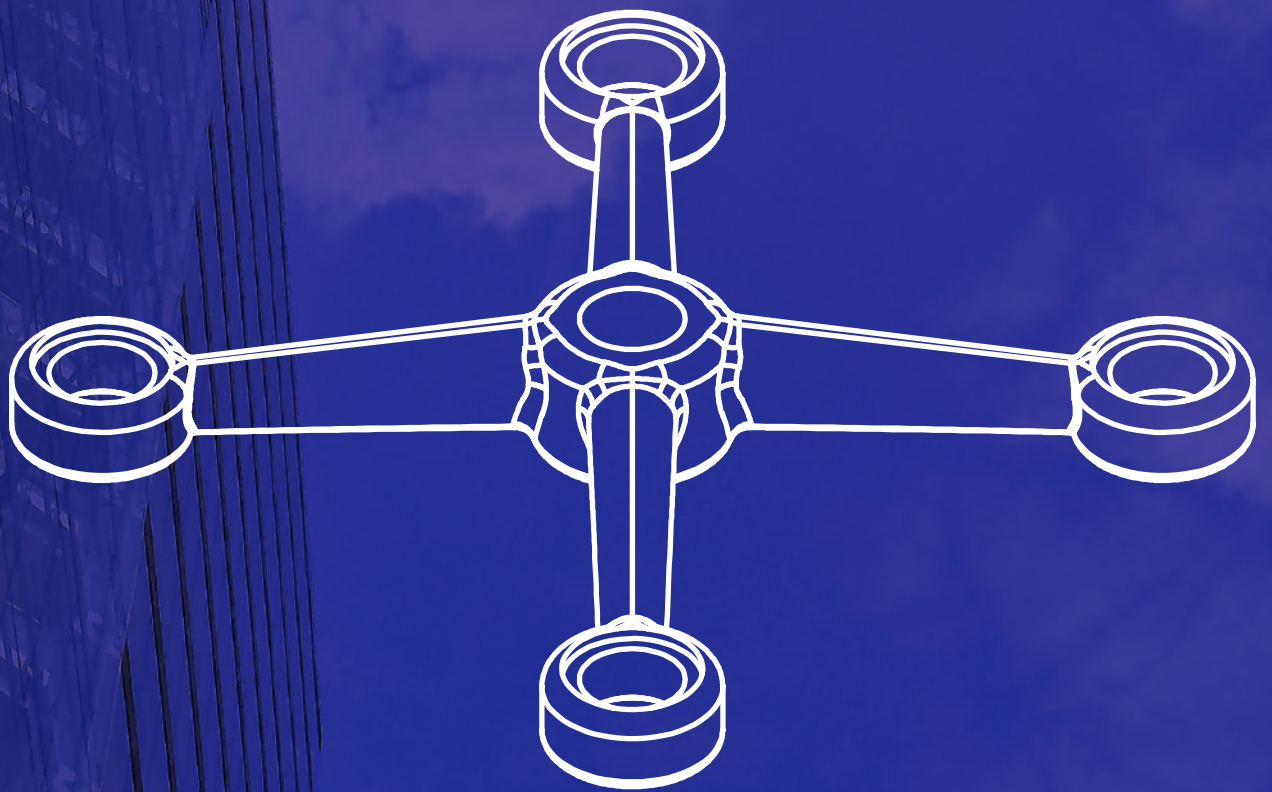

13.1 - ARAÑAS Y RÓTULAS FITECHNIC.....	572-582
13.2 - MURO-CORTINA SILICONGLASS.....	583



13.1 - ARAÑAS Y RÓTULAS FITECHNIC



SISTEMAS FACHADA DE VIDRIO

ESTRUCTURAL ABOTONADO

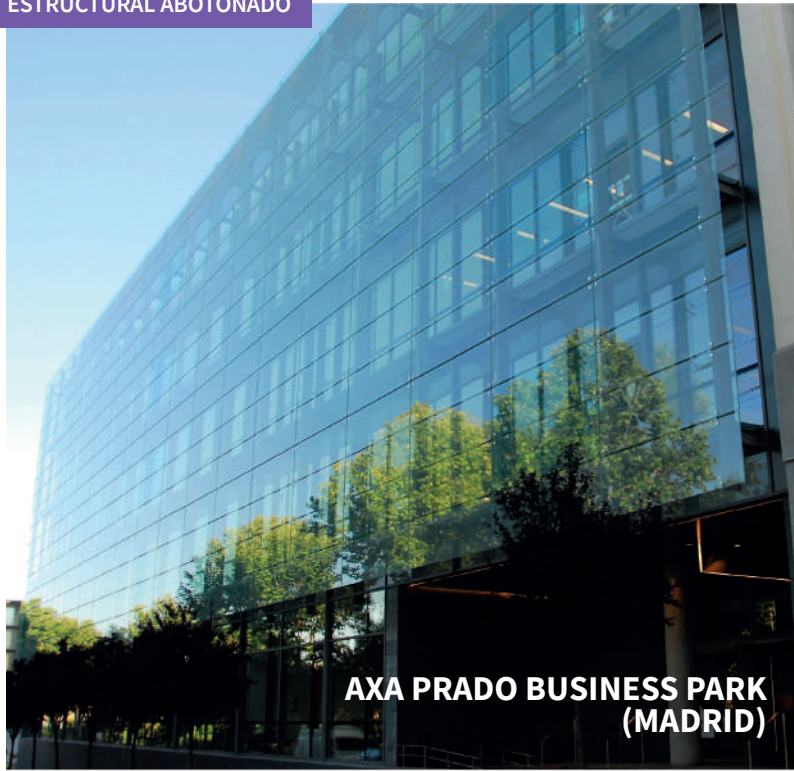

AXA PRADO BUSINESS PARK (MADRID)

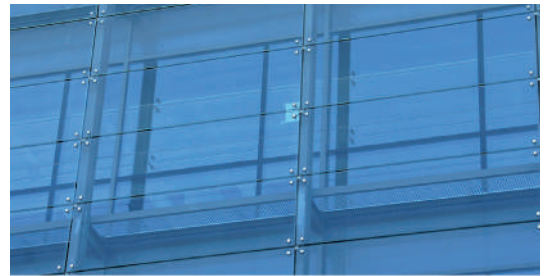

ARAÑAS Y RÓTULAS FITECHNIC | ESTRUCTURAL ABOTONADO

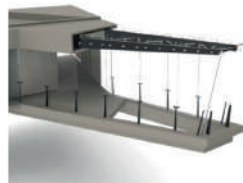

ABRANTE "LA GOMERA" (ISLAS CANARIAS)

AISI-316

FITECHNIC

CERTIFICACIONES DE CALIDAD

- Estudio/Desarrollo productos por ensayos de elementos finitos
- Ensayos laboratorios independientes
- Certificaciones de calidad Acero Inoxidable AISI-316
- Certificaciones según ensayos de carga SGS

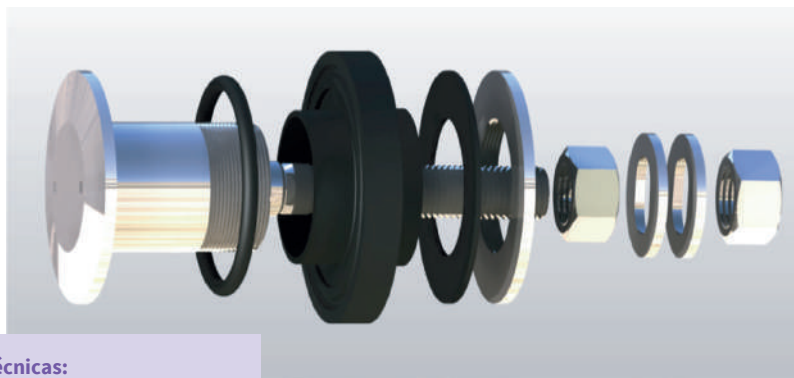
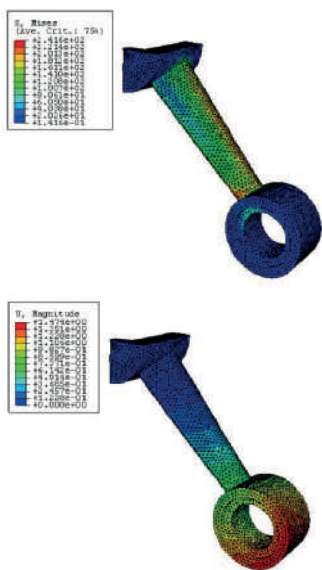

Características técnicas:

- Sistema V.E.A. (vidrio estructural abotonado)
- Paneles de vidrios sujetos puntualmente por medio de arañas
- Ingeniería de fachada estructural optimizando la transparencia de la fachada

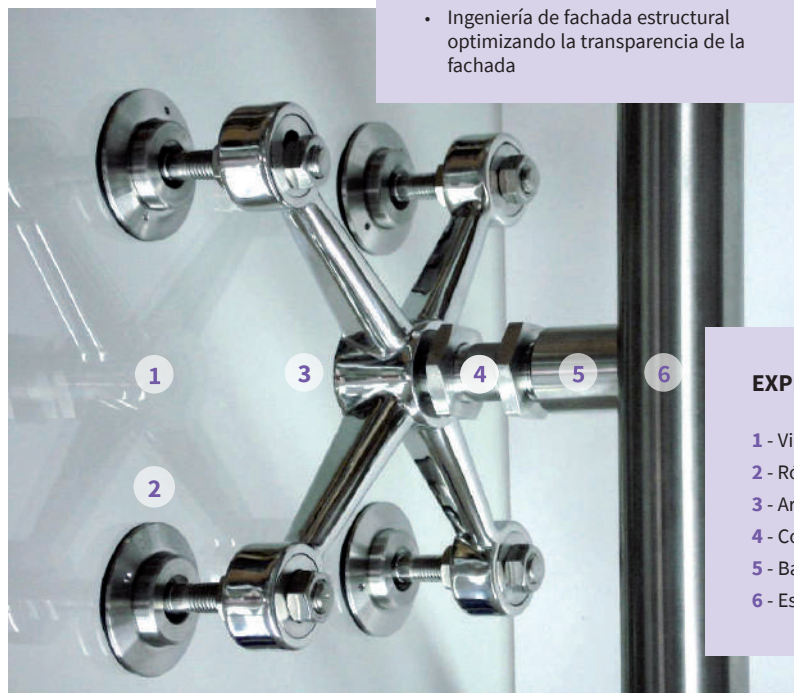

EXPLICACIÓN FUNCIONAL DEL SISTEMA 1 FITECHNIC

- 1 - Vidrio
- 2 - Rótula para unión de vidrio a la araña referencia 2421
- 3 - Araña 4 brazos referencia 2413
- 4 - Conector roscado de unión de araña a base soporte ref. 2426
- 5 - Base soporte de la estructura referencia 2427
- 6 - Estructura

3 SISTEMAS DE INSTALACIÓN

AISI-316

SISTEMA 1

Araña + Tapa (FIX TP) + Conector (FIC 71)
+ Base soporte (FITT)

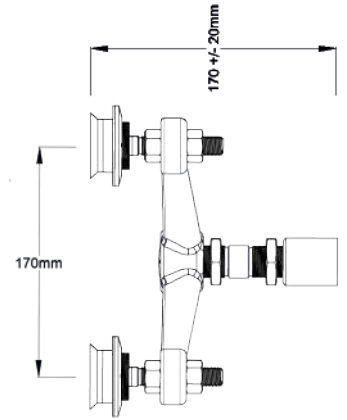
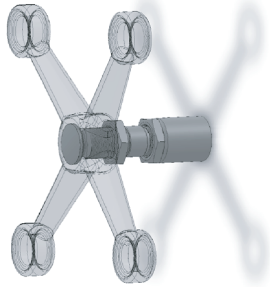

SISTEMA 2

Araña + Tapa (FIX TP) + Arandela Interior (FIX AR)
+ Tornillo M12 (FIEM 12)

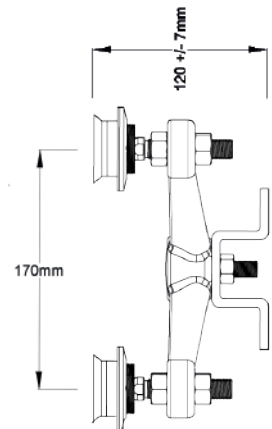
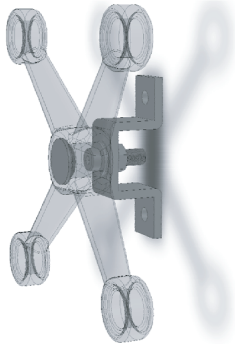

SISTEMA 3

Araña + Tornillo M12 a M18 (depende del proyecto)

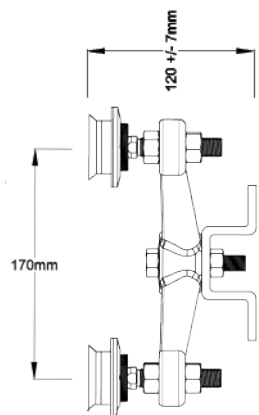
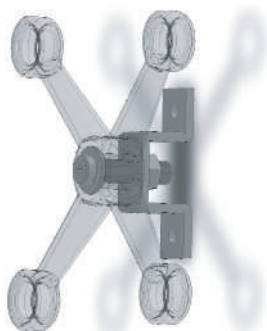

ARAÑAS

AISI-316

ARAÑA DE UNIÓN 1 PUNTO 85 MM

Acabados:

Inox brillo **2400 IB**

ARAÑA DE UNIÓN 1 PUNTO 102 MM

Acabados:

Inox brillo **2400.1 IB**

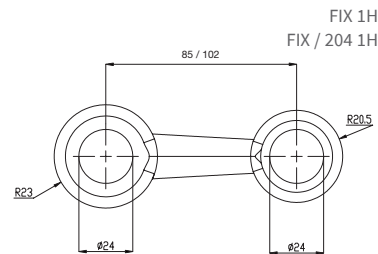

ARAÑA DE UNIÓN 2 PUNTOS 170 MM

Acabados:

Inox brillo **2401 IB**

ARAÑA DE UNIÓN 2 PUNTOS 204 MM

Acabados:

Inox brillo **2401.1 IB**

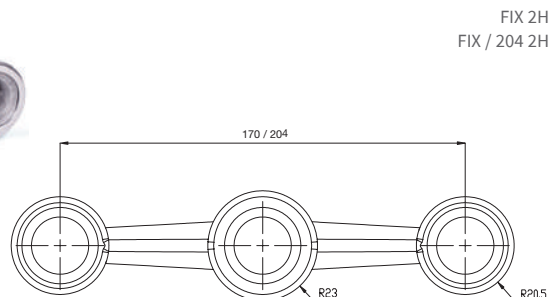

ARAÑA DE UNIÓN 1 PUNTO 85 MM

Acabados:

Inox brillo **2410 IB**

ARAÑA DE UNIÓN 1 PUNTO 102 MM

Acabados:

Inox brillo **2410.1 IB**

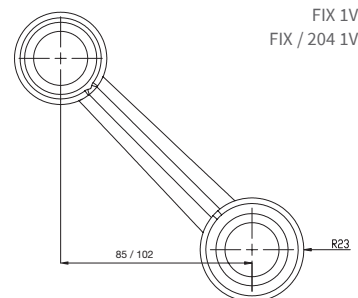

ARAÑA DE UNIÓN 2 PUNTOS 170 MM

Acabados:

Inox brillo **2411 IB**

ARAÑA DE UNIÓN 2 PUNTOS 204 MM

Acabados:

Inox brillo **2411.1 IB**

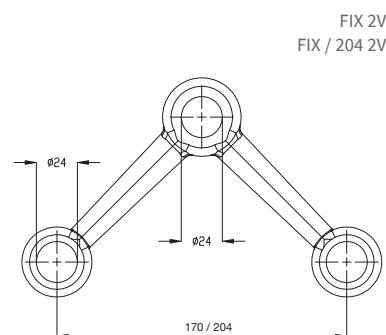

ARAÑA DE UNIÓN 3 PUNTOS 170 MM

Acabados:

Inox brillo **2412 IB**

ARAÑA DE UNIÓN 3 PUNTOS 204 MM

Acabados:

Inox brillo **2412.1 IB**

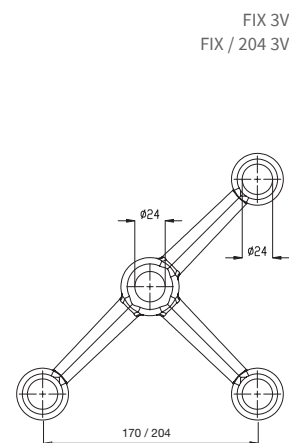



ARAÑA DE UNIÓN 4 PUNTOS 170 MM

Acabados:

Inox brillo **2413 IB**

ARAÑA DE UNIÓN 4 PUNTOS 204 MM

Acabados:

Inox brillo **2413.1 IB**

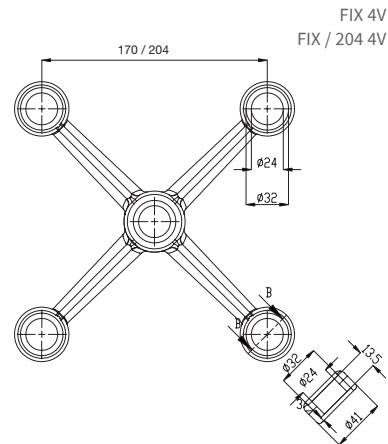

FIX 4V
FIX / 204 4V

ARAÑA FIJACIÓN LATERAL 170 MM

Acabados:

Inox brillo **2415 IB**

ARAÑA FIJACIÓN LATERAL 204 MM

Acabados:

Inox brillo **2415.1 IB**

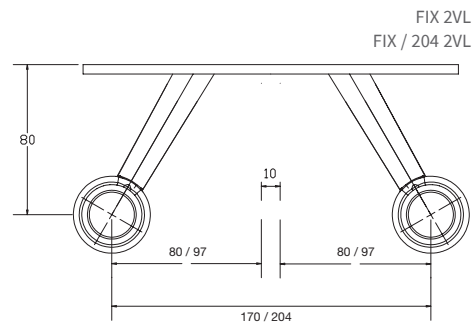

FIX 2VL
FIX / 204 2VL

ARAÑA FIJACIÓN LATERAL 80 MM

Acabados:

Inox brillo **2440 IB**

ARAÑA FIJACIÓN LATERAL 100 MM

Acabados:

Inox brillo **2440.1 IB**



FIX 1HL
FIX / 204 1HL

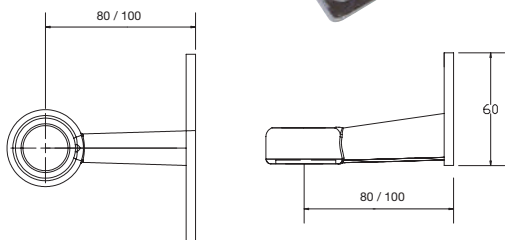

ARAÑA ADAPTADOR DE ESQUINA

Acabados:

Inox brillo **2414 IB**

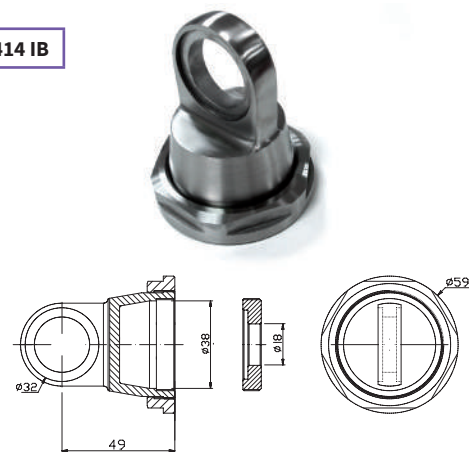

FI RL

TETÓN 100 MM M14

Para embutir en estructura y colocar rótulas fijas en la instalación de barandillas

2417

FITT100

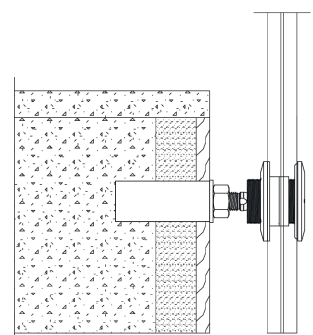

**ARAÑA SIN TALADROS
PARA DOBLE ACRISTALAMIENTO**

PF-H

Adaptable a refs. 2426 y 2427

Acabados:

Inox brillo **2442 IB**

*Bajo pedido



**ARAÑA SIN TALADROS
Ø 80 MM**

PF-C

Acabados:

Inox brillo **2443 IB**

*Bajo pedido

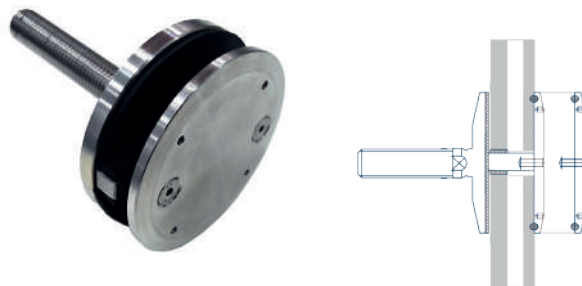

RÓTULAS ARTICULADAS

AISI-316

RÓTULA ARTICULADA

Vidrio 12/21 mm

Incluye 2 arandelas y dos tuercas DIN439

RE1221 M14

2421

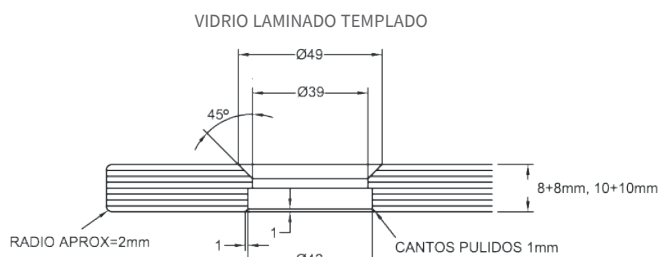
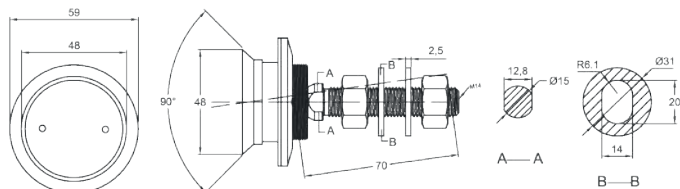
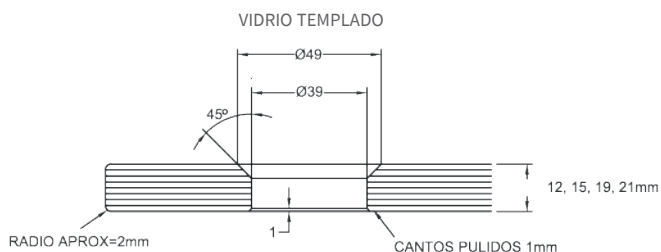

**RÓTULA ARTICULADA
CON TAPÓN EXTERIOR**

RT1221 M14

Vidrio 12/21 mm

Incluye 2 arandelas y dos tuercas DIN439

2422

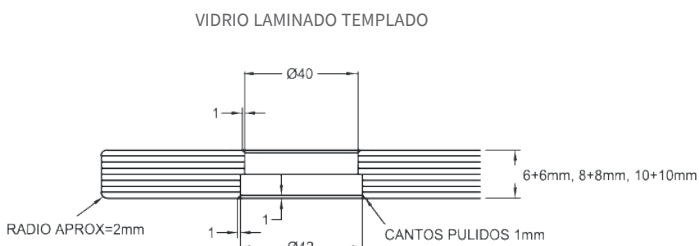
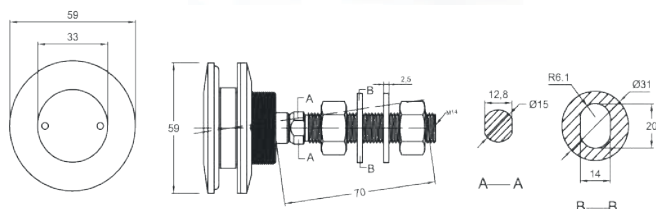
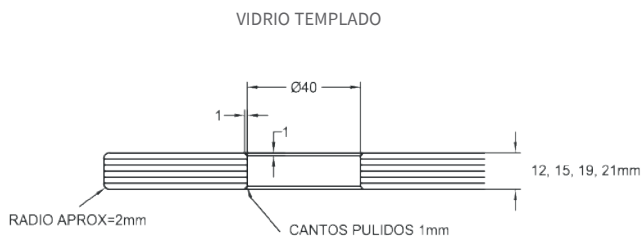



RÓTULA ARTICULADA

Vidrio de cámara 28/36 mm

Incluye 2 arandelas y dos tuercas DIN439

2423

SEPARADOR DE NYLON PARA CÁMARA

2423.1

*Especificar grosor de cámara

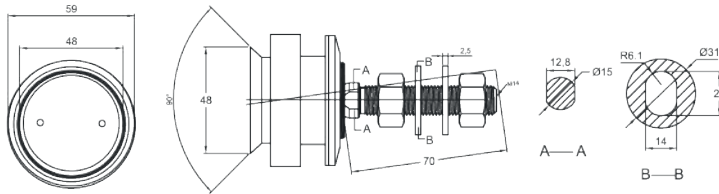

RD2836 M14
FISEP

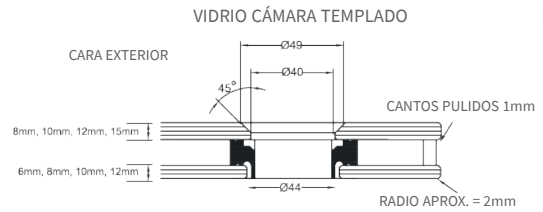

VIDRIO CÁMARA LAMINADO TEMPLADO

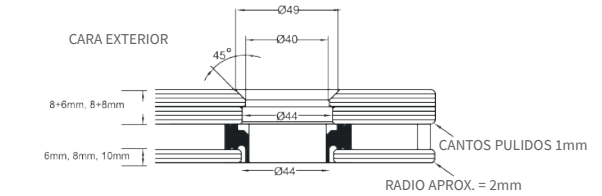

RÓTULA ARTICULADA

Vidrio 10/21 mm

Incluye 2 arandelas y dos tuercas DIN439

Fijación exterior

2424

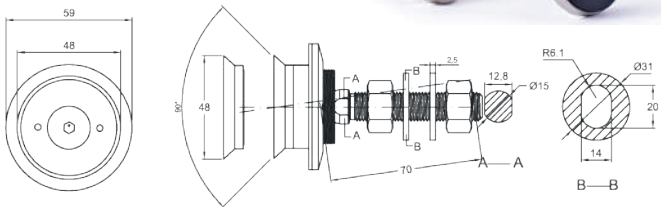

RCE1021 M14

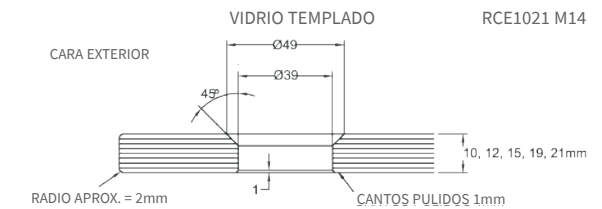

VIDRIO LAMINADO TEMPLADO

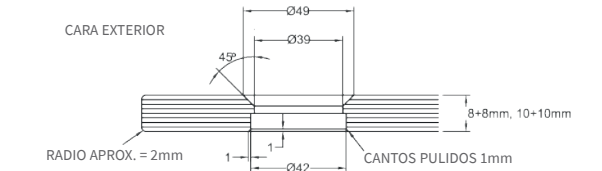

RÓTULA ARTICULADA CON TAPÓN EXTERIOR

Vidrio 10/21 mm

Incluye 2 arandelas y dos tuercas DIN439

Fijación exterior

2425

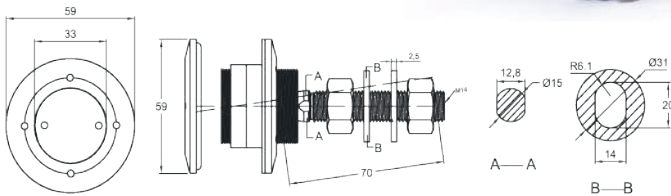

RCT1021 M14

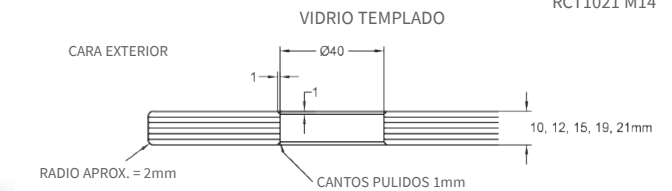

VIDRIO LAMINADO TEMPLADO

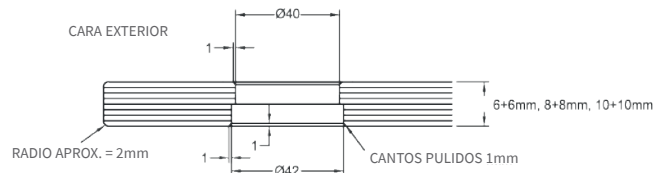

RÓTULA ARTICULADA CON TAPÓN EXTERIOR

Vidrio de cámara 28/36 mm

Incluye 2 arandelas y 2 tuercas DIN439 y separador de nylon

2428

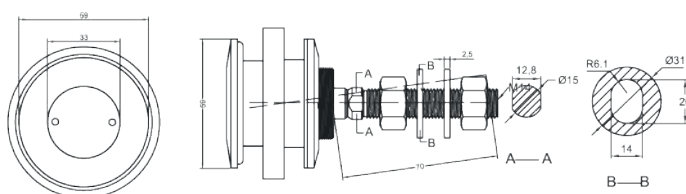

VIDRIO CÁMARA TEMPLADO

RDT2836 M14

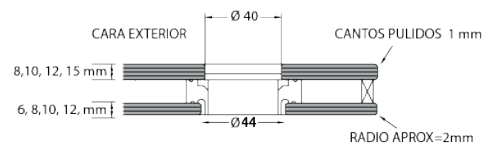

VIDRIO CÁMARA LAMINADO TEMPLADO

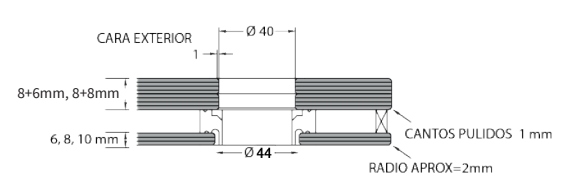

RÓTULA ARTICULADA PARA EMBUTIR EN LAMINADO O CÁMARA

Vidrio interior 10/12 mm
 Vidrio exterior según proyecto
 Incluye 2 arandelas y 2 tuercas DIN 439

2429

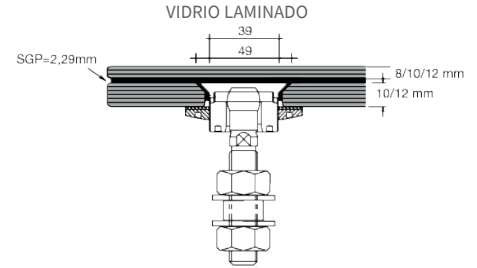
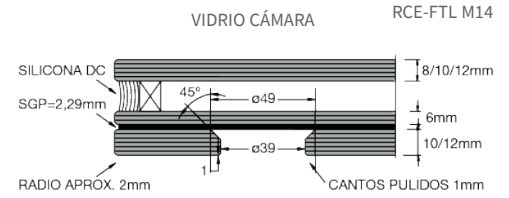
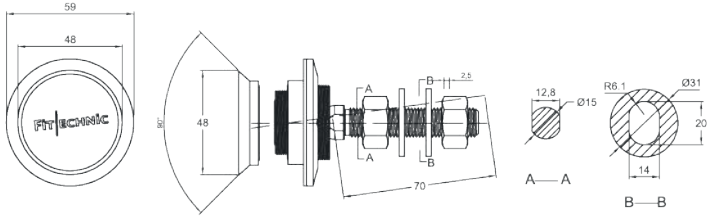

RÓTULA ARTICULADA PARA ADHESIVO

Adhesivo estructural tipo UV, DP490, TSSA
 Sin taladro

2436

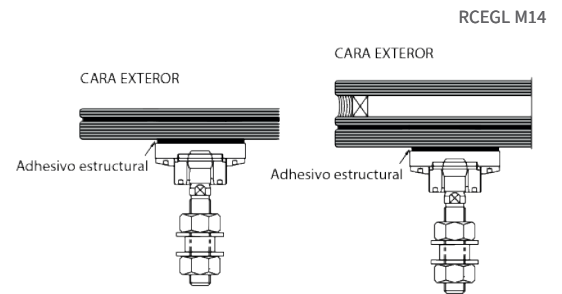
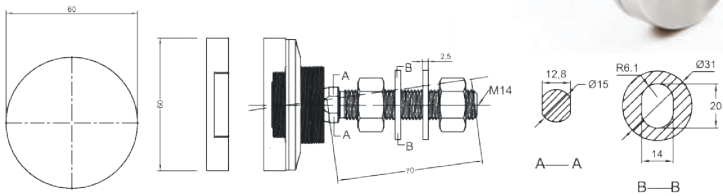

RÓTULAS FIJAS

AISI-316

RÓTULA FIJA

Vidrio 10/16 mm
 Incluye 2 arandelas y 2 tuercas DIN439
 Fijación exterior

2433

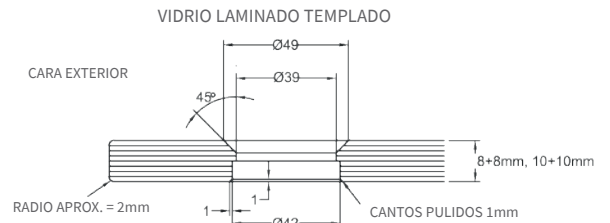
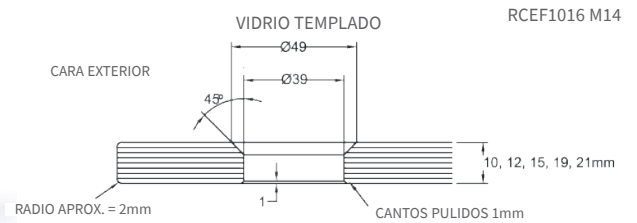
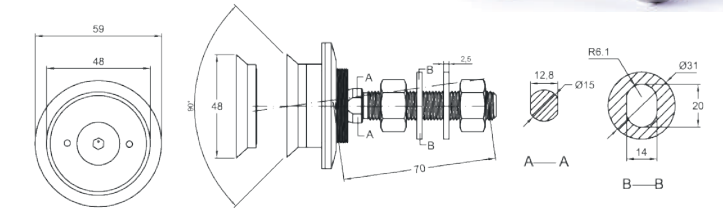

RÓTULA FIJA CON TAPÓN EXTERIOR

Vidrio 10/21 mm
 Incluye 2 arandelas y 2 tuercas DIN439
 Fijación exterior

2434

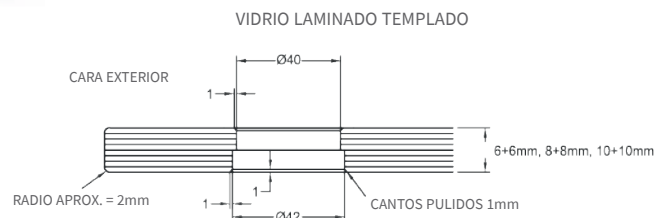
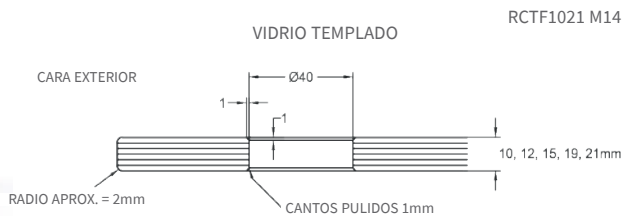
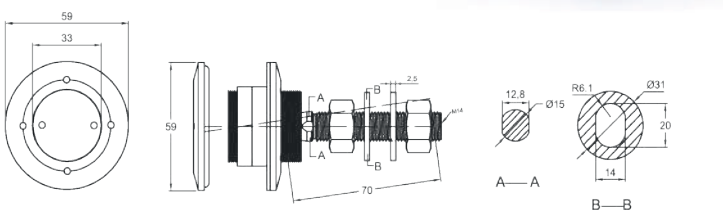



COMPLEMENTOS

AISI-316

BASE SOPORTE

Para sujetar a la estructura junto con ref. 2426 en Sistema 1

2427

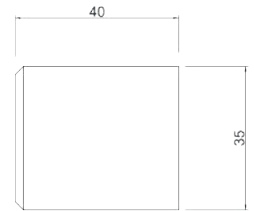
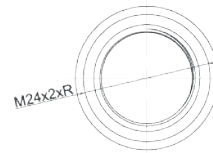

FI TT

CONECTOR / TORNILLO DE UNIÓN DE ARAÑA A ESTRUCTURA M24

Doble rosca derecha/izquierda y dos tuercas de doble bloqueo DIN439 Sistema 1

2426

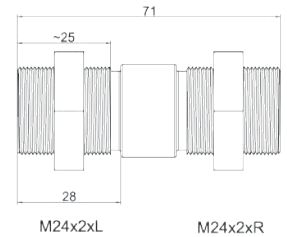
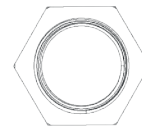

FI C71

BASE OMEGA PARA SISTEMAS 2 Y 3

2441

Tornillo no incluido Ref. 2416 / 2416.1

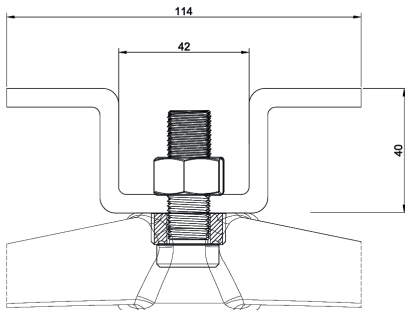

BASE SOPORTE PARA SISTEMA 1

2444

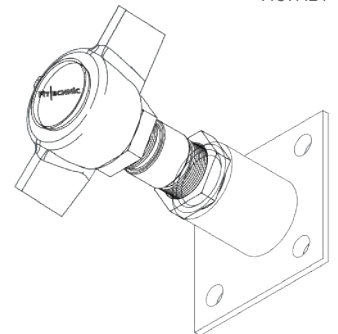
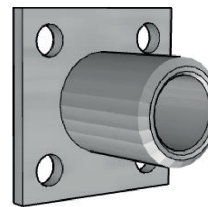

FI CTM24

TORNILLO PARA SISTEMAS 2 Y 3

M14x50 2416.1

FIEM14

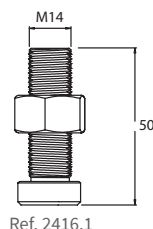

ARANDELA INTERIOR PARA SISTEMA 2

M14 2419.1

FIXAR M14

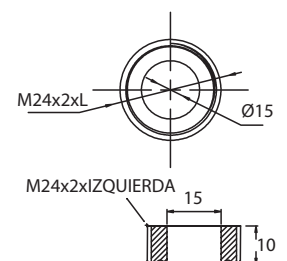

INSTALACIONES CON CABLE

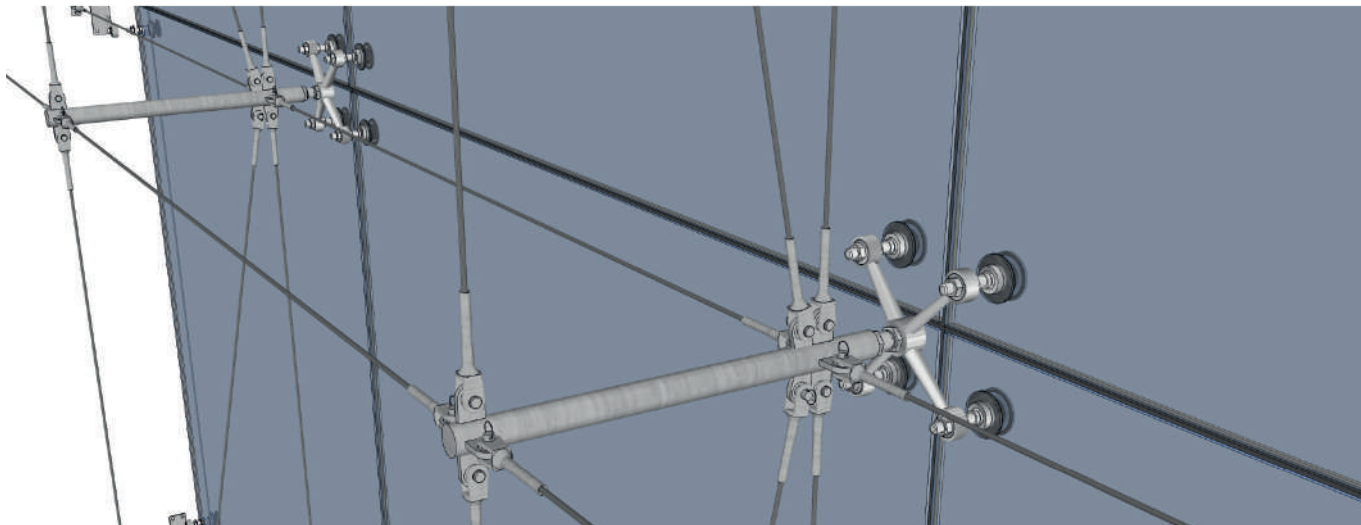

ESTRUCTURAS TENSIONADAS

Una fachada de acristalamiento estructural con acero inoxidable cables de acero permite fachadas más limpias sin estructuras metálicas. usando arañas conectado con varilla y conectado a través de los cables tensados podemos obtener máxima transparencia y óptima visual apariencia estética.



FI-CAB

Cable en acero inoxidable AISI 316 con tensor y 2 horquillas de diámetro variable

FI-VAR

Vástago en acero inoxidable AISI316 con tensor y 2 horquillas de diámetro variable

FI-BR

Biela en acero inoxidable AISI316 con placas de acero para horquillas, para la conexión de arañas y cables/varillas.



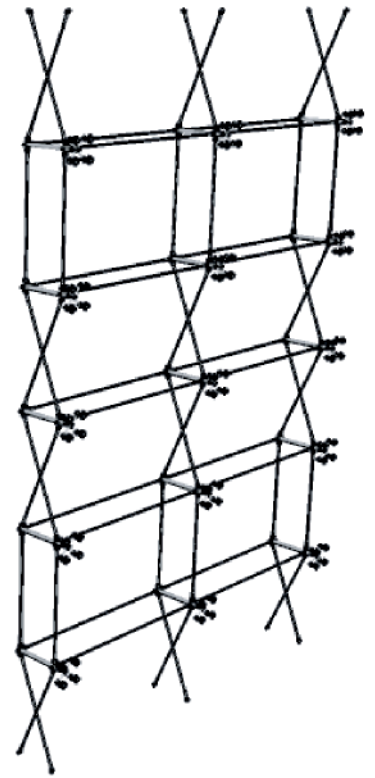
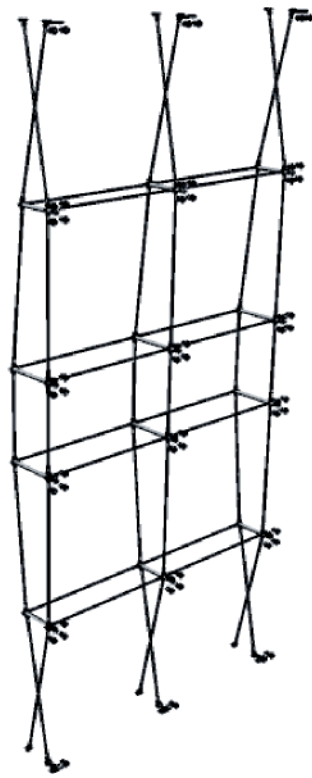

SISTEMA F12H-ROD

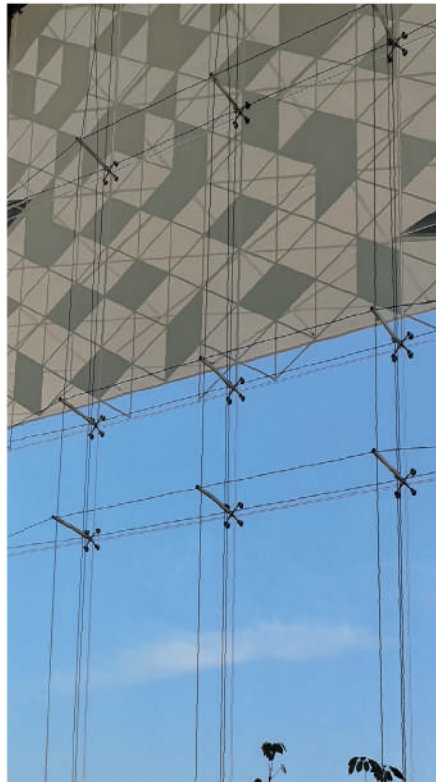

SISTEMA F14V-CAB



SISTEMA F14V-ROD

SILICON GLASS **NOVEDAD**

Silicon Glazing es un sistema híbrido de muro cortina con doble fijación:

- Fijaciones mecánicas ocultas
- Silicona estructura

Este sistema se puede aplicar a cualquier tipo de vidrio (doble IGU, templado, laminado, esmaltado o comunes) y materiales de revestimiento de fachadas (acero inoxidable, acero, aluminio, piedra, madera).



- CE Marking / EN 13830
- ISO 9001 Quality Management
- Air permeability class: AE (* M ax)
- Water tightness class: R750 (* M ax)
- Wind load test: 2000 / 3000P a
- Impact class: I5 / E5
- Ucw = from 1.0 W / m2.K

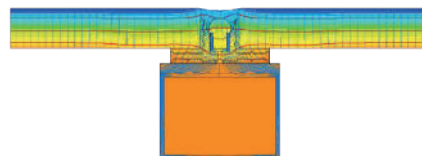

APLICACIONES SG-12

Vidrio simple laminado o templado para interior o aplicación de fachadas exteriores, cubiertas y marquesinas.

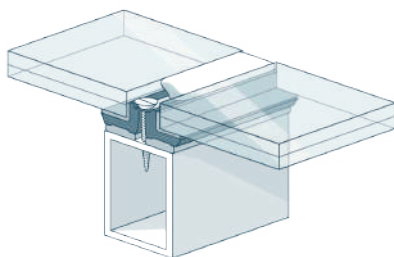

ACABADO CLARO



VIDRIO ESTRUCTURAL



INSTALACIÓN FÁCIL

APLICACIONES SG-22+

Vidrio doble acristalamiento para fachada exterior y aplicación de cubiertas, con rotura de puente térmico.

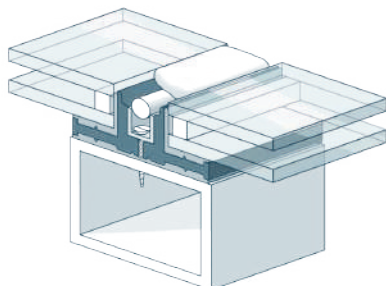

ACTUACIÓN TÉRMICA



VIDRIO ESTRUCTURAL



INSTALACIÓN FÁCIL

PROYECTOS PERSONALIZADOS

Fachadas y cubiertas especiales con SG12, SG22+ o otros perfiles de silicona HTV fabricados a medida.

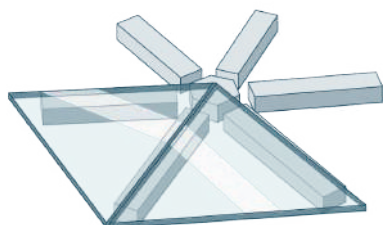

ESTRUCTURAS COMPLEJAS



PERSONALIZADO



INGENIERÍA